

TJEP CPX 27 Concrete Pin, Electrogalvanized

Application

Fixation of drywall tracks.

Fixation of wiring accessories/conduit fasteners.

Approval



Fire protection approval

Material properties

Total length L: 16, 20, 25, 30, 35 & 40 mm

Black collated strip.

Electrogalvanized, average thickness $\geq 5 \mu\text{m}$.

Hardness 53-56 HRc

Suitable tools

TJEP CP-40 GAS 3G concrete nailer or similar.

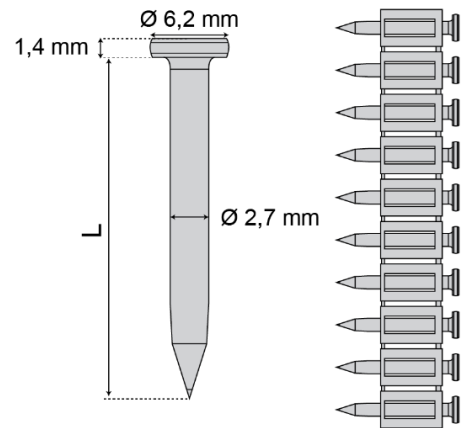

Product list

Range	Length of shank (L)	Item no.
CPX 27/16	16	839290
CPX 27/20	20	839291
CPX 27/25	25	839292
CPX 27/35	35	839294

RECOMMENDED LOAD

TJEP CPX 27 Range	Embedment	Characteristic resistance	
		N _{Rk} (kN)	V _{Rk} (kN)
Concrete C30/37	H _{nom} = 12 mm	0,36	0,15
	H _{nom} = 20 mm	0,74	0,47